

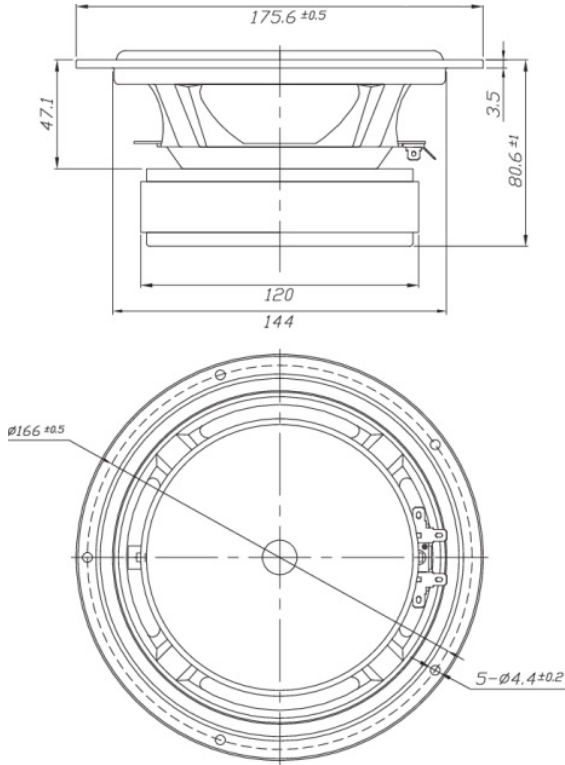

DSA175-8 6-1/2" Designer Series Aluminum Cone Woofer 8 Ohm



PARAMETERS

Impedance	8 ohms
Re	5.8 ohms
Le	0.85 mH @ 1 kHz
Fs	38.36 Hz
Qms	1.66
Qes	0.35
Qts	0.29
Mms	24.2g
Cms	0.71 mm/N
Sd	128.7 cm ²
Vd	67.6 cm ³
BL	9.75 Tm
Vas	18.7 liters
Xmax	5.3 mm
VC Diameter	35.5 mm
SPL	88.1 dB @ 2.83V/1m
RMS Power Handling	70 watts
Usable Frequency Range (Hz)	38 - 7,500 Hz

FEATURES

- Cosmetic frame with low profile lip, designed for front mounting—no countersinking required!
- Low distortion motor system with copper shorting ring
- Black anodized aluminum cone, half roll rubber surround for durability and accurate reproduction
- Optimized to yield the smallest possible box volume and lowest 3 dB down point
- Smooth frequency response and linear roll-off simplify filter design, guaranteeing good results with off-the-shelf crossovers

IMPEDANCE/PHASE

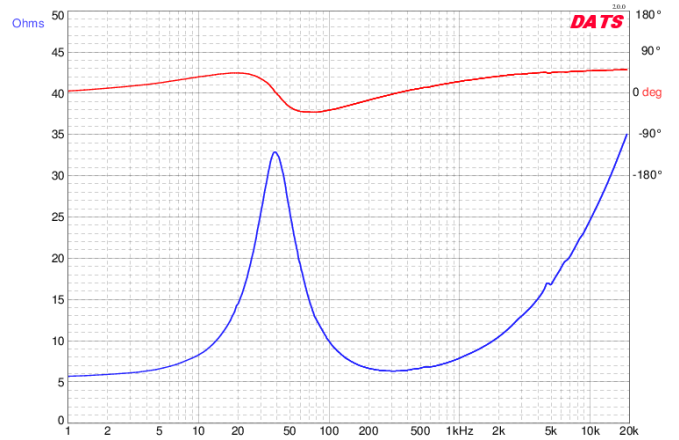

FREQUENCY RESPONSE

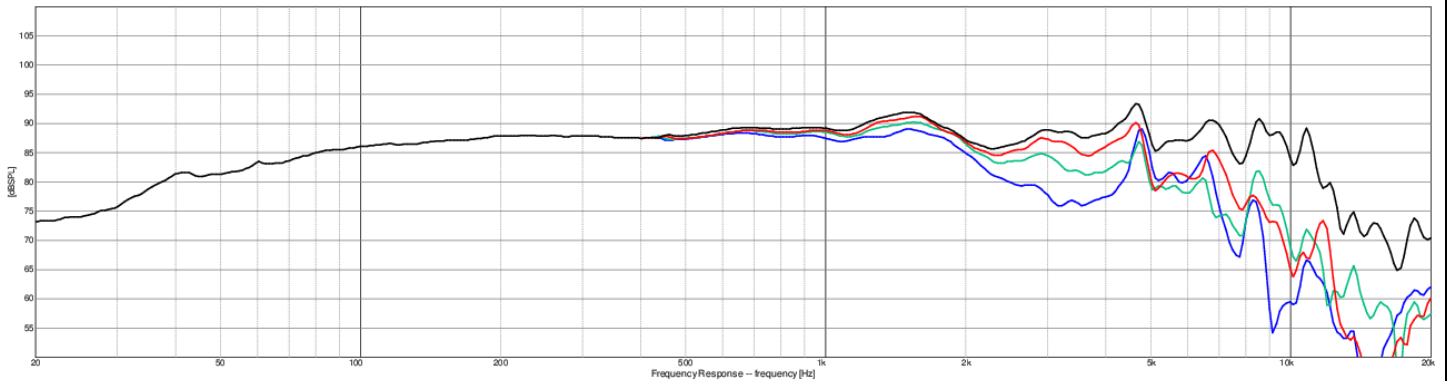

Note: 1/24th octave smoothing - nearfield response included in graph below 450 Hz.

Black = 0°
Red = 15°
Green = 30°
Blue = 45°