

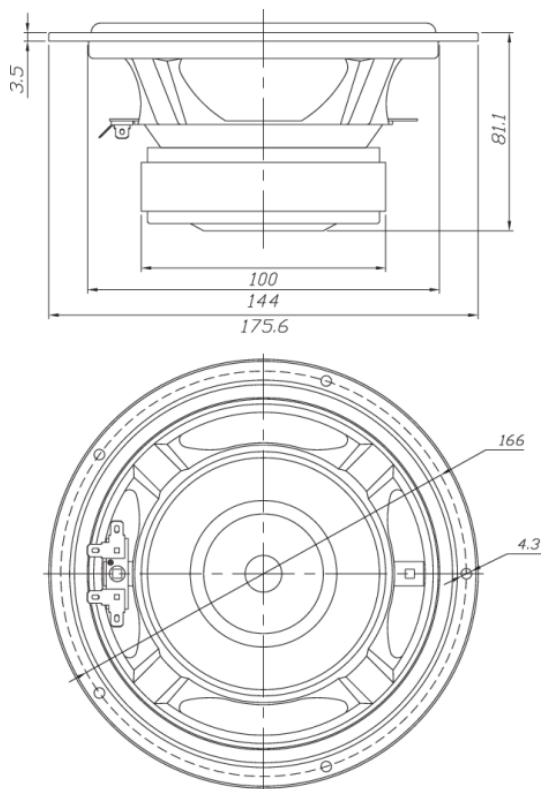

DA175-8 7" Aluminum Cone Woofer

DA175-8



PARAMETERS

Impedance	8 ohms
Re	5.9 ohms
Le	1.14 mH
Fs	39.0 Hz
Qms	3.31
Qes	0.70
Qts	0.58
Mms	25.17g
Cms	0.66 mm/N
Sd	132.7 cm ²
Vd	56.4 cm ³
BL	7.17 Tm
Vas	16.3 liters
Xmax	4.25 mm
VC Diameter	35 mm
SPL	85 dB @ 1W/1m
RMS Power Handling	50 watts
Usable Frequency Range (Hz)	35 - 10,000 Hz

FEATURES

- Special composite dustcap
- Stamped steel frame provides a very high-class and professional look
- Aluminum cone offers a flat frequency response in the passband region with very low distortion

IMPEDANCE/PHASE

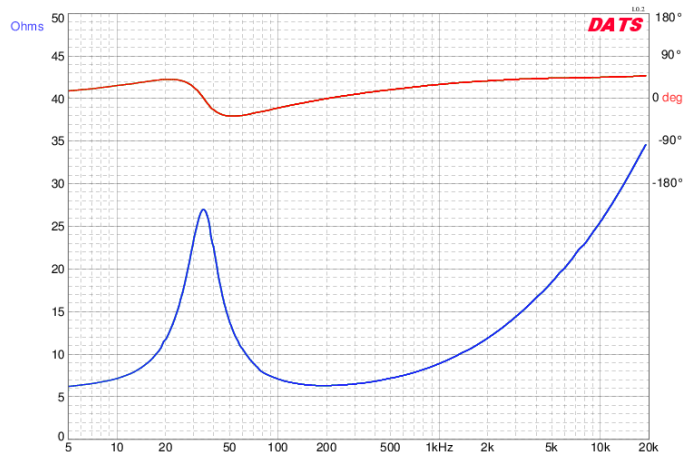

FREQUENCY RESPONSE

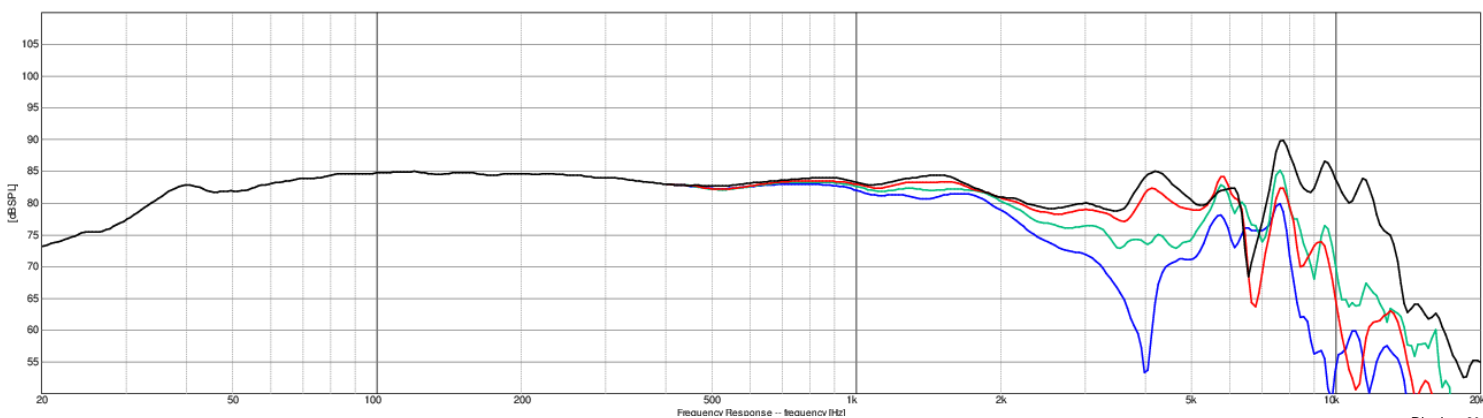

Note: 1/24th octave smoothing - nearfield response included in graph below 450 Hz.

Black = 0°
Red = 15°
Green = 30°
Blue = 45°